

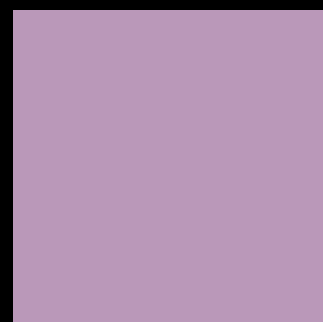

HENRAD

DISCOVER ALTO PLAN E

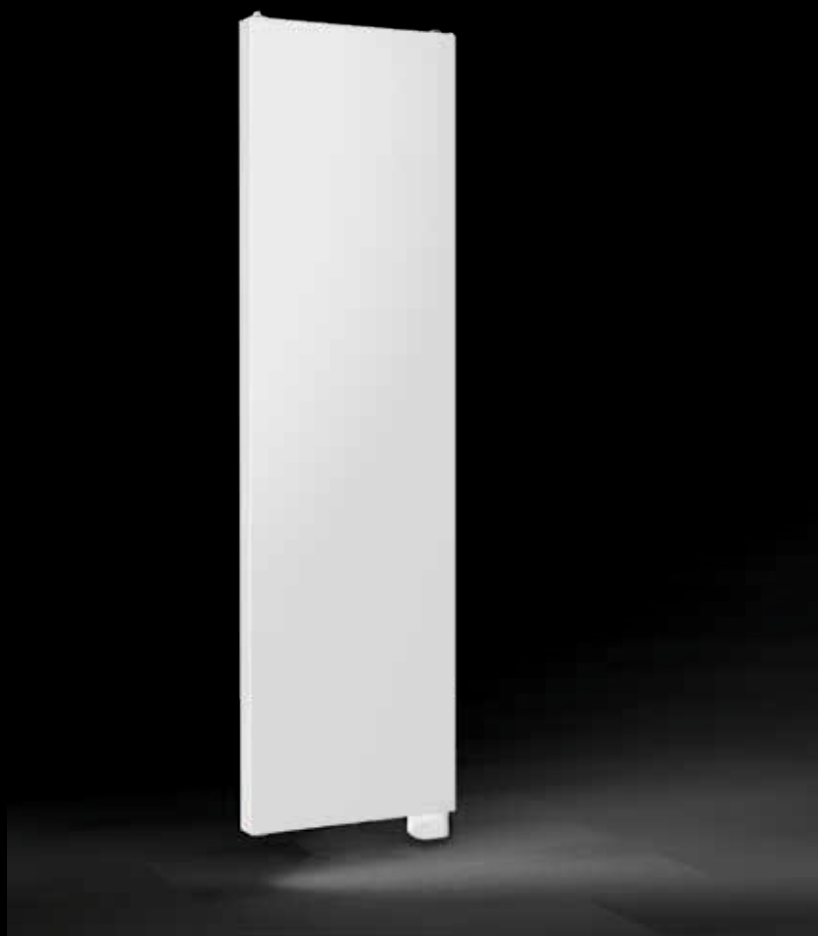

ELECTRICAL RANGE

GENERAL INFORMATION

ALTO PLAN E

The Alto Plan E combines the advantages of a vertical electric radiator with a sleek and decorative appearance. With its flat front, it stands out in the most beautiful interiors, even in small rooms, which saves space.

Product: decorative electrical vertical panel radiator with a flat front
Pre-installed: prefilled with heating liquid. RF-receiver mounted including 0,8 m of insulated cable with power plug.
Also supplied: wall brackets, ETA safety screws and plugs, screws and plugs, assembly instructions and RF-thermostat
Lugs: no lugs
Packaging: Every radiator is sturdily packaged in high-quality cardboard and wrapped in plastic. The radiator's characteristics are shown on the label:
Electric power – height – length.
Warranty: 10 years for the radiator and 2 years for the electrical components, as long as the installation instructions have been followed and Henrad's warranty conditions have been met.
Paint process: All radiators are degreased, phosphated, primed and powder-coated in Henrad white 9016 as standard.
Colours: Henrad white 9016 + 35 different Henrad colours and about 200 RAL-colours are possible
Conformity: EcoDesign 2018 (EU Regulation 2015/1188)
Technical data: Voltage 220-240V ~50Hz, CE, IPX4, Class II
Type: 11
Height: 1800 mm
Lengths: 500 | 600 | 700 mm
Electric power: 1.250 | 1.500 | 1.750 Watt

H1800			
Length	L 500	L 600	L 700
W	1.250 W	1.500 W	1.750 W
Art. Nr.	0275A181105	0275A181106	0275A181107



RF remote control

ECODESIGN
2018 COMPLIANT



2021

INTELLIGENT RF-THERMOSTAT

Temperature setting: Adjustable from + 10 °C to + 30 °C

4 possible operating modes: Auto (programming), Comfort, Eco, Frost protection

General use: 7-day program: Up to six different profiles can be assigned to each day.

Super Comfort Function: The temperature is increased by 2 °C, adjustable from 20 to 120 minutes.

Boost: The output is temporarily increased to the maximum, adjustable from 10 to 60 minutes.

Weekly programmable.

Open window detection: Automatic switch to frost protection mode when a significant temperature drop is detected.

Child safety: The control panel can be locked.

Control: Connection to the radiator is quick and easy. Can control multiple radiators in one zone.

Ergonomic: backlit display, adjustment is simple and intuitive.

ELECTRICAL RANGE

MOUNTING AND INSTALLATION

This is a class II heater with an IPX4 protection rating and, as such, it can be installed in volume 2 or 3 of the bathroom (see figure), provided that it is shielded from water splashes, that the radiator is out reach of persons in the bath or under the shower, and that it is plugged in a wall socket placed in volume 3. The battery-operated thermostat should be positioned in volume 3 and out of water splash range (IP20).

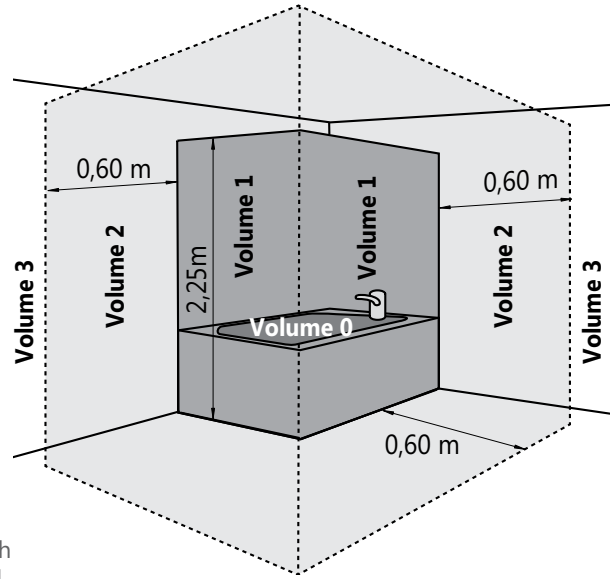

The radiator must be installed with the heating element vertical and the control box in the lower section. It is prohibited to install the device with the control box in the upper section or with the heating element horizontal. The device is class II insulated and, therefore, it cannot be earthed. The device should be powered by a single-phase current of 220-240 V ~ 50 Hz.

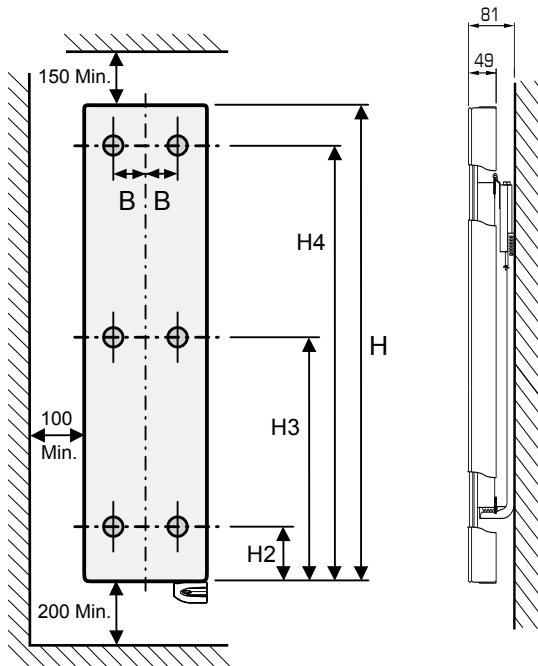

Length	B
L 500	130
L 600	180
L 700	230

Height	H2	H3	H4
1800	160	830	1500

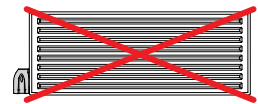
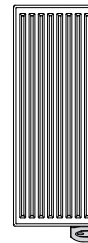
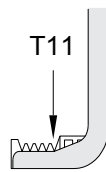

The complete mounting instruction can be downloaded from our website under technical informations of Alto Plan E or via QR-code:



HENRAD

- | | | | | | |
|---|--|---|---|---|---|
|  Australia |  Belgium |  Cyprus |  Czechia |  France |  Germany |
|  Greece |  Iceland |  Lithuania |  Luxembourg |  Norway |  Poland |
|  Russia |  Slovenia |  Sweden |  Netherlands |  Tunisia |  Ukraine |

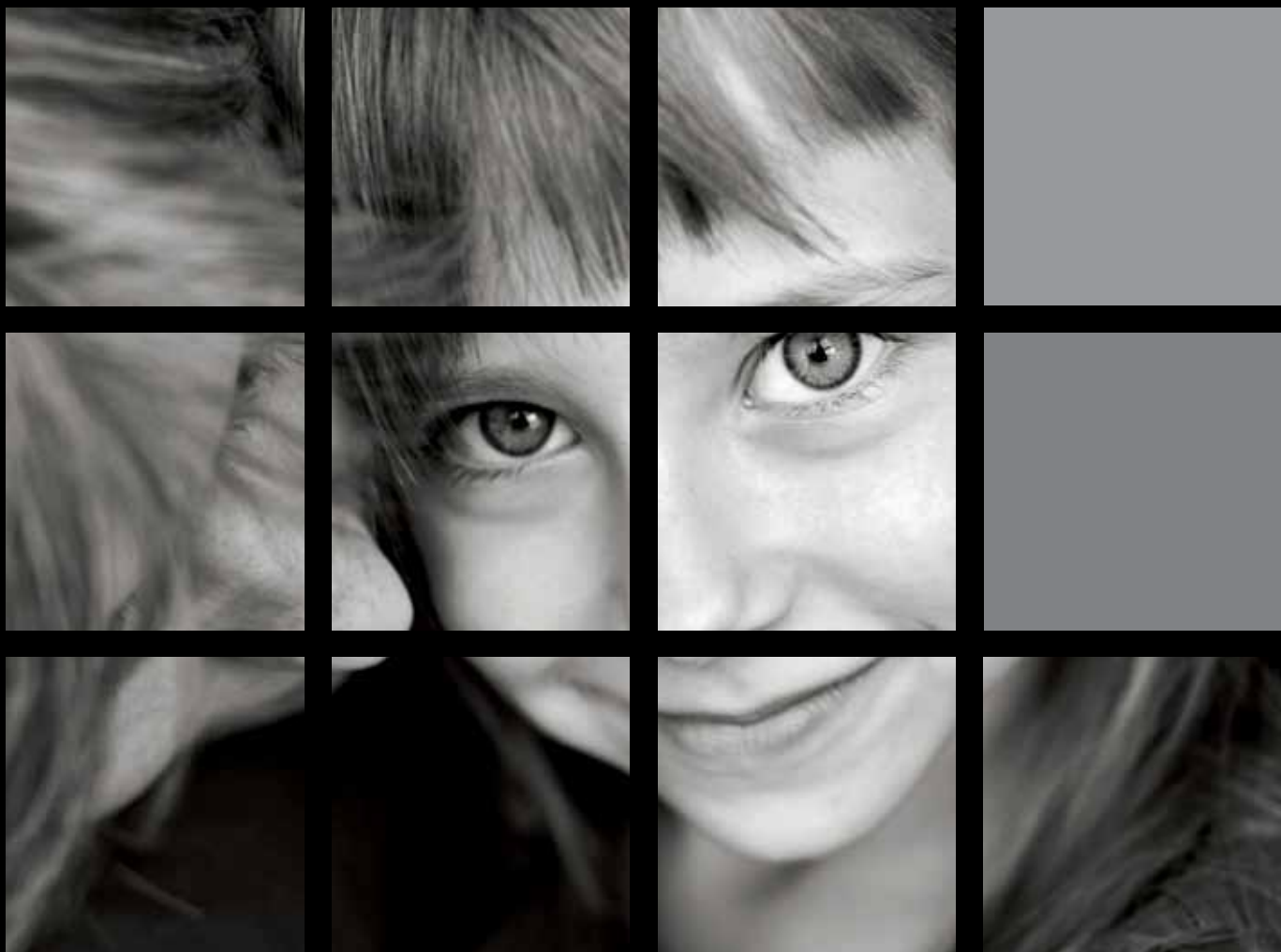

HENRAD

Henrad N.V.
Welvaartstraat 14 box 6 | 2200 Herentals | Belgium
T. +32 (0)14 212 075

WWW.HENRAD.EU

