

Galva



HENRAD

DISCOVER GALVA



GENERAL INFORMATION

GALVA

A standard steel panel radiator with an extra protective galvanised coating for humid spaces. The ideal panel radiator for your bathroom.

Product:	the naked panel radiator with a protective galvanised coating
Finishing:	protective galvanised coating
Also supplied:	L-brackets, screws, plugs, blind plug, air vent and installation instructions
Connections:	4 x ½" female connection
Lugs:	2 pairs of mounting lugs
Packaging:	Every radiator is sturdily packaged in high-quality cardboard and wrapped in plastic. The radiator's characteristics are shown on the label: type – height – length.
Warranty:	10 years, as long as the installation instructions have been followed and Henrad's warranty conditions have been met.
Paint process:	All radiators are degreased, phosphated, cathodically primed and powder-coated in Henrad white 9016 as standard.
Colours:	Henrad white 9016 + 35 different Henrad colours and about 200 RAL-colours are possible
Heat cost allocator:	Suitable for heat cost allocators, both electronic and according to the evaporation principle (covered by the norm of EN834 & EN835).
Max. operating pressure:	10 bar (tested to 13 bar)
Max. operating temperature:	110 °C
Conformity:	in accordance with EN442
Types:	11 21 22 33
Heights:	400 500 600 700 900 mm
Lengths:	400 – 1.600 mm
Depths:	60 77 100 158 mm



TYPE OVERVIEW

Calculation factor
per meter
at 75/65/20°C
according to EN442

Characteristic equation:

$$\Phi = K_M \times \Delta T^n$$

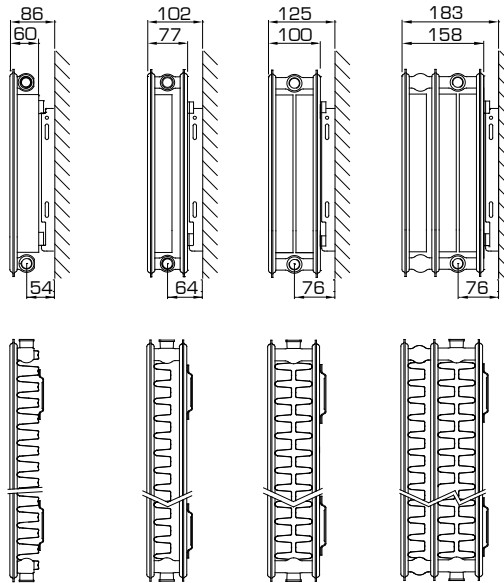

Height		T11	T21	T22	T33	Centre distance
400	W	687	1.000	1.281	1.805	350
	kg	11,68	18,78	21,83	32,67	
	l	2,34	4,67	4,67	6,87	
	m ²	2,95	3,37	4,92	7,38	
	n	1,31	1,33	1,33	1,33	
500	W	848	1.210	1.535	2.169	450
	kg	14,99	23,84	27,77	41,53	
	l	2,80	5,63	5,63	8,33	
	m ²	3,80	4,31	6,33	9,49	
	n	1,30	1,33	1,33	1,34	
600	W	1.000	1.409	1.778	2.514	550
	kg	18,30	28,90	33,70	50,40	
	l	3,25	6,60	6,60	9,80	
	m ²	4,66	5,24	7,74	11,61	
	n	1,29	1,33	1,33	1,35	
700	W	1.142	1.597	2.011	2.841	650
	kg	21,33	33,50	39,13	58,47	
	l	3,77	7,63	7,63	11,37	
	m ²	5,51	6,18	9,15	13,72	
	n	1,29	1,34	1,34	1,35	
900	W	1.397	1.941	2.453	3.448	850
	kg	27,40	42,70	50,00	74,60	
	l	4,80	9,70	9,70	14,50	
	m ²	7,22	8,05	11,97	17,96	
	n	1,29	1,36	1,35	1,37	

W=heat output per meter / kg=weight per meter / l=content per meter / m²=surface per meter / n=exponent
The manufacturer reserves the right to alter any of the specifications shown in this document without prior notice.

GALVA

HEAT OUTPUTS ACCORDING TO EN442



EN442 (W) 70/50/20°C

EN442 (W) 55/45/20°C

HENRAD NV/PL24/0022/E005

Height	400			
Type	11	21	22	33
W/m 75/65/20°C	687	1.000	1.281	1.805
400	205 141 0107041104	297 203 0107042104	380 259 0107042204	537 367 0107043304
500	257 177 0107041105	372 254 0107042105	475 324 0107042205	671 458 0107043305
600	308 211 0107041106	446 304 0107042106	571 389 0107042206	806 550 0107043306
700	359 247 0107041107	520 355 0107042107	666 454 0107042207	940 642 0107043307
800	411 282 0107041108	595 406 0107042108	761 519 0107042208	1.074 733 0107043308
900	462 317 0107041109	669 457 0107042109	857 584 0107042209	1.208 825 0107043309
1000	513 353 0107041110	743 507 0107042110	952 649 0107042210	1.343 917 0107043310
1100	565 388 0107041111	818 558 0107042111	1.047 713 0107042211	1.477 1.009 0107043311
1200	616 423 0107041112	892 609 0107042112	1.142 778 0107042212	1.611 1.100 0107043312
1400	719 494 0107041114	1.041 710 0107042114	1.332 908 0107042214	1.880 1.284 0107043314
1600	821 564 0107041116	1.190 812 0107042116	1.523 1.038 0107042216	2.148 1.467 0107043316

500			
11	21	22	33
848	1.210	1.535	2.169
254 175 0107051104	360 246 0107052104	456 311 0107052204	644 439 0107053304
317 219 0107051105	450 307 0107052105	571 389 0107052205	804 548 0107053305
381 262 0107051106	540 368 0107052106	684 467 0107052206	965 657 0107053306
445 306 0107051107	630 430 0107052107	798 544 0107052207	1.127 767 0107053307
508 350 0107051108	720 491 0107052108	912 622 0107052208	1.288 877 0107053308
571 393 0107051109	810 553 0107052109	1.027 700 0107052209	1.449 986 0107053309
635 437 0107051110	900 614 0107052110	1.140 778 0107052210	1.610 1.096 0107053310
699 481 0107051111	990 675 0107052111	1.254 855 0107052211	1.771 1.205 0107053311
762 525 0107051112	1.080 737 0107052112	1.369 933 0107052212	1.932 1.315 0107053312
889 612 0107051114	1.260 860 0107052114	1.597 1.089 0107052214	2.254 1.534 0107053314
1.016 700 0107051116	1.440 983 0107052116	1.825 1.244 0107052216	2.575 1.753 0107053316

600			
11	21	22	33
1.000	1.409	1.778	2.514
300 207 0107061104	419 286 0107062104	528 360 0107062204	745 505 0107063304
375 259 0107061105	524 357 0107062105	661 451 0107062205	931 632 0107063305
450 311 0107061106	628 429 0107062106	793 541 0107062206	1.116 758 0107063306
525 363 0107061107	733 501 0107062107	925 631 0107062207	1.303 884 0107063307
600 414 0107061108	838 572 0107062108	1.057 721 0107062208	1.489 1.010 0107063308
675 466 0107061109	943 644 0107062109	1.189 811 0107062209	1.675 1.137 0107063309
750 518 0107061110	1.048 715 0107062110	1.321 901 0107062210	1.861 1.263 0107063310
825 570 0107061111	1.153 787 0107062111	1.454 991 0107062211	2.047 1.389 0107063311
900 621 0107061112	1.258 858 0107062112	1.586 1.081 0107062212	2.234 1.516 0107063312
1.050 725 0107061114	1.467 1.002 0107062114	1.850 1.261 0107062214	2.606 1.769 0107063314
1.200 829 0107061116	1.676 1.144 0107062116	2.114 1.442 0107062216	2.978 2.021 0107063316

Core assortment (Henrad white 9016) available ex factory within 10 days.
 Core assortment is subject to change, please refer to www.henrad.eu for the latest information.
 Delivery time depends on the model, please refer to your distributor.

GALVA

On the label: Art. 0107 09 22 04
 4-CONNECTIONS NAKED GALVA T11-33: 0107 

HENRAD NV/PL24/0022/E005

Height	700			
Type	11	21	22	33
W/m 75/65/20°C	1.142	1.597	2.011	2.841
400	343 237 0107071104	474 323 0107072104	597 406 0107072204	840 569 0107073304
500	428 296 0107071105	592 403 0107072105	747 508 0107072205	1.050 711 0107073305
600	514 355 0107071106	711 484 0107072106	896 610 0107072206	1.260 854 0107073306
700	599 414 0107071107	830 565 0107072107	1.045 711 0107072207	1.470 996 0107073307
800	686 473 0107071108	948 646 0107072108	1.194 813 0107072208	1.680 1.138 0107073308
900	771 532 0107071109	1.066 726 0107072109	1.343 914 0107072209	1.890 1.280 0107073309
1000	857 591 0107071110	1.185 807 0107072110	1.492 1.016 0107072210	2.100 1.422 0107073310
1100	942 650 0107071111	1.304 888 0107072111	1.641 1.117 0107072211	2.310 1.564 0107073311
1200	1.028 709 0107071112	1.422 968 0107072112	1.791 1.219 0107072212	2.520 1.707 0107073312
1400	1.199 828 0107071114	1.659 1.130 0107072114	2.089 1.422 0107072214	2.940 1.991 0107073314
1600	1.370 946 0107071116	1.896 1.291 0107072116	2.388 1.626 0107072216	3.360 2.276 0107073316

900			
11	21	22	33
1.397	1.941	2.453	3.448
419 289 0107091104	573 388 0107092104	726 492 0107092204	1.016 685 0107093304
523 361 0107091105	717 485 0107092105	907 615 0107092205	1.270 857 0107093305
628 433 0107091106	861 583 0107092106	1.089 739 0107092206	1.524 1.028 0107093306
733 506 0107091107	1.004 680 0107092107	1.271 862 0107092207	1.779 1.200 0107093307
838 578 0107091108	1.148 777 0107092108	1.452 985 0107092208	2.032 1.371 0107093308
942 650 0107091109	1.291 874 0107092109	1.634 1.108 0107092209	2.286 1.542 0107093309
1.047 723 0107091110	1.434 971 0107092110	1.815 1.231 0107092210	2.540 1.713 0107093310
1.152 795 0107091111	1.578 1.068 0107092111	1.997 1.354 0107092211	2.795 1.885 0107093311
1.257 867 0107091112	1.721 1.165 0107092112	2.179 1.478 0107092212	3.049 2.056 0107093312
1.467 1.012 0107091114	2.008 1.359 0107092114	2.541 1.724 0107092214	3.556 2.399 0107093314
1.676 1.156 0107091116	2.295 1.554 0107092116	2.904 1.970 0107092216	4.065 2.742 0107093316

CONNECTION POSSIBILITIES

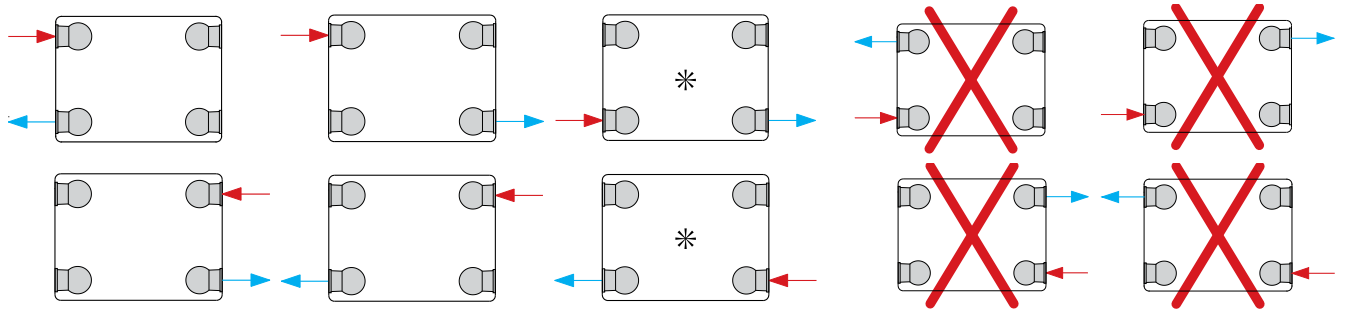

* = a reduction in heatoutput will occur when combining low temperature heating with a high temperature difference between inlet and outlet.

MOUNTING DIMENSIONS

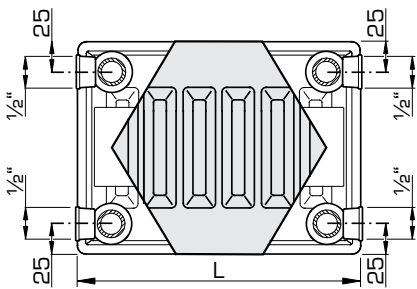

L-BRACKETS

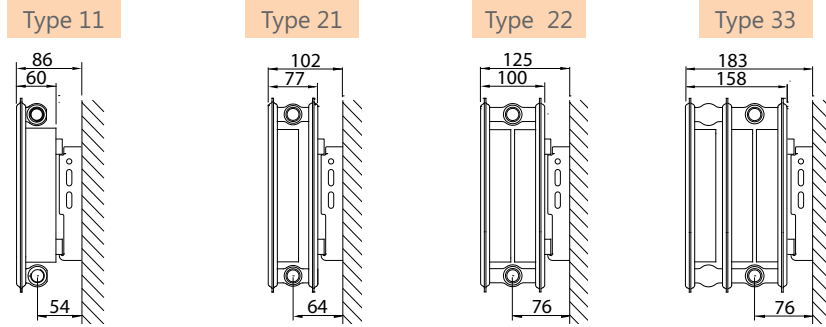

Remark T11-33: images show the short wall distances, wall distances increase with +15 mm when using the long bracket side.

Types 11-33		Art. N°	Height	
L-bracket (galvanised)	z1			z2
	290	270	R512404	400
	390	370	R512405	500
	490	470	R512406	600
	590	570	R512407	700
	790	770	R512409	900

LUG POSITIONS

Type 11

L	A
400	117
500-1600	150

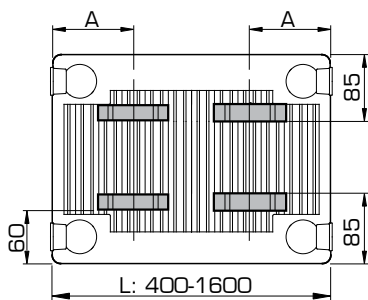

Types 21/22/33

L	A
400-1600	133

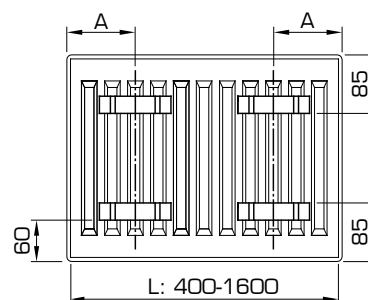

Australia • Belgium • Cyprus • Czechia • France • Germany • Greece • Iceland • Lithuania
Luxembourg • Norway • Poland • Slovenia • Sweden • The Netherlands • Tunisia • Ukraine

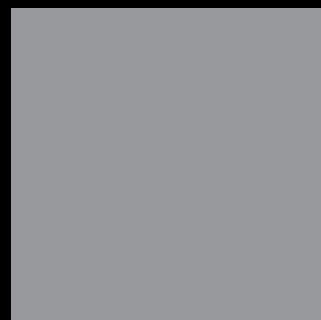

HENRAD

Henrad nv
Welvaartstraat 14 box 6 • 2200 Herentals • Belgium

WWW.HENRAD.EU

